

-Pro-

15G350

SOUND REINFORCEMENT

This 15" cone transducer is designed for professional high level, high performance sound reinforcement systems. It features a 3" voice coil diameter, copper wire material. The magnetic structure is vented in order to maximise heat dissipation, increasing power handling while reducing power compression. The result is a loudspeaker that combines high efficiency, extended frequency response and thermal and mechanical durability.

Este transductor de 15" ha sido diseñado para aplicaciones profesionales de alto nivel. Se caracteriza por la utilización de una bobina de 3", circuito magnético simétrico y ventilado, y chasis de aluminio fundido a presión. El resultado es un altavoz que combina alta eficiencia, extensa respuesta en frecuencia y elevada resistencia térmica y mecánica.



PREDICTED LOW FREQUENCY RESPONSE • Bass-reflex cabinet, Vb=80.00 l, fb=50.0 Hz

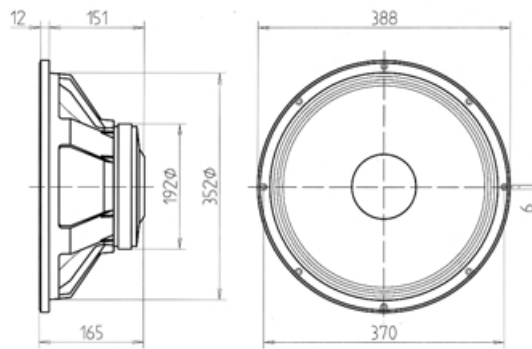
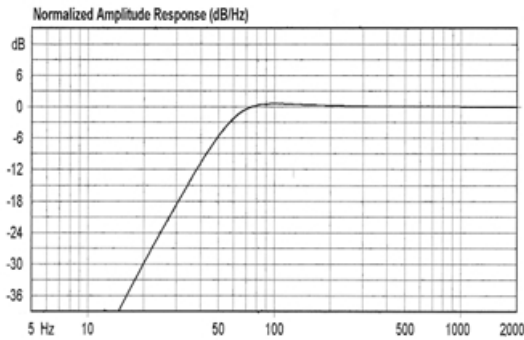

SPECIFICATIONS

Nominal diameter	380 mm. 15.28 in.
Rated impedance	8 ohms.
Power capacity*	250 w RMS
Program Power	500 Watts.
Sensitivity	99 dB, 2.83v @ 1m @ 2π
Frequency range	30-4000 Hz
Recom. enclosure vol.	60/150 l 2.1/5.3 ft. ³
Voice coil diameter	77 mm. 3 in.
Magnetic assembly weight	6.5 kg. 14.3 lb.
BL factor	18 N/A
Moving mass	0.076 kg.
Voice coil length	16 mm.
Air gap height	7 mm.
X damage (peak to peak)	30 mm.

MOUNTING INFORMATION

Overall diameter	388 mm. 15.28 in.
Bolt circle diameter	370 mm. 14.56 in.
Baffle cutout diameter:	
-Front mount	352 mm. 13.85 in.
-Rear mount	355 mm. 13.97 in.
Depth	165 mm. 6.49 in.
Volume displaced by driver	7 l 0.25 ft. ³
Net weight	8 kg. 17.6 lb.
Shipping weight	9 kg. 19.8 lb.

FREQUENCY RESPONSE & DISTORTION CURVES, MAGN. On axis, 1w @ 1m.

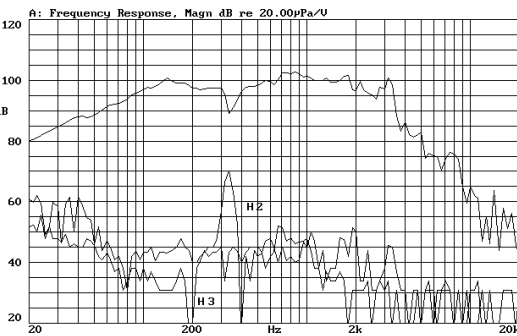

TIME RESPONSE, MAGN.

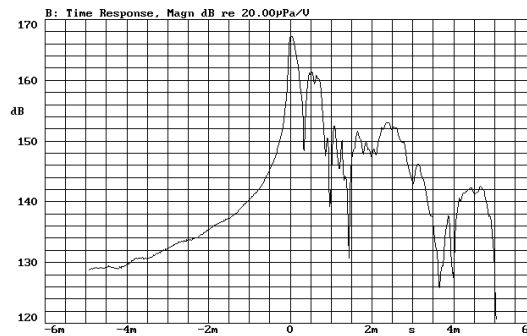

FREQUENCY RESPONSE, PHASE. On axis, 1w @ 1m.

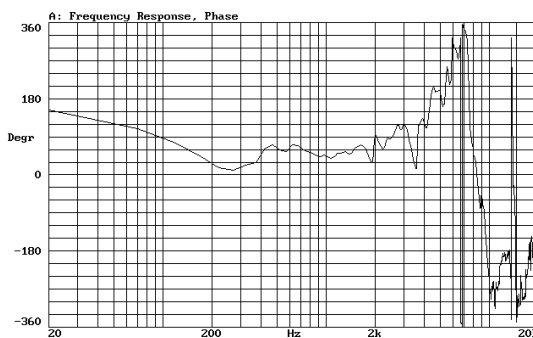

FREE AIR IMPEDANCE CURVE

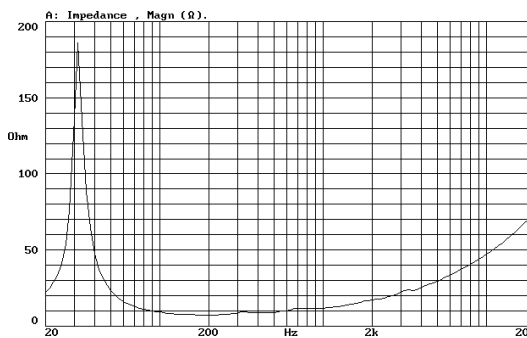

MATERIALS

Basket	Cast aluminium
Cone	Paper
Surround	Plasticised cloth
Voice coil	Copper
Magnet	Ferrite

THIELE-SMALL PARAMETERS**

Resonant Frequency, fs	32 Hz
D.C. Voice Coil Resistance, Re	5.7 ohms.
Mechanical Quality Factor, Qms	8.7
Electrical Quality Factor, Qes	0.27
Total Quality Factor, Qts	0.262
Equivalent Air Volume to Cms, Vas	312.2 l
Mechanical Compliance, Cms	324.5 µm/N
Mechanical Resistance, Rms	1.76 kg/s
Efficiency, ηp (%)	3.4
Effective Surface Area, Sd(m ²)	0.083 m ²
Maximum Displacement, Xmax	4.5 mm.
Displacement Volume, Vd	373 cm. ³
Voice Coil Inductance, Le @ 1kHz	0.8 mH

VOICE COIL INDUCTANCE CURVE

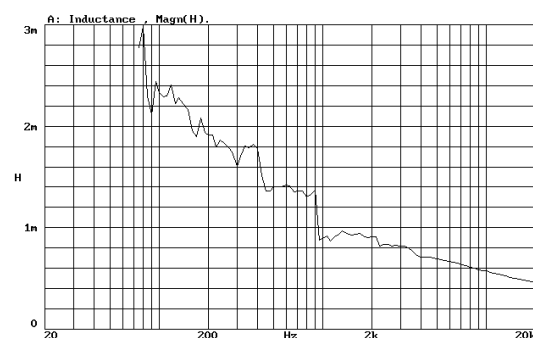

Re + Red(w) CURVE

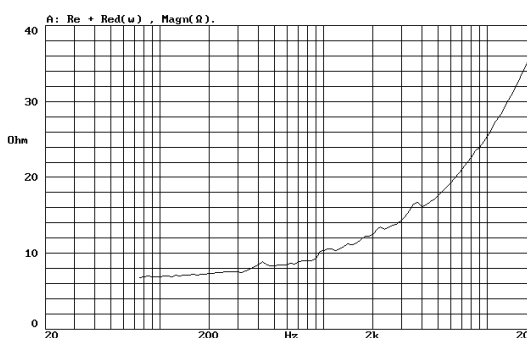

NOTES

*The power capacity corresponds to the RMS maximum value that can dissipate the loudspeaker when a sinus signal is applied for a period of at least two hours. Program power is defined as the transducer's ability to handle normal music program material.

** T-S parameters are measured after an exercise period using a preconditioning power test, using a velocity-current laser transducer, and will reflect the long term parameters, once the loudspeaker has been working for a short period of time.

NOTAS

*La potencia admisible corresponde a la máxima potencia RMS que puede disipar el altavoz durante al menos dos horas, cuando se le aplica una señal senoidal determinada.

Por potencia programa se entiende la capacidad del altavoz en el manejo de señales transitorias, como sería el proporcionado por el contenido de un pasaje musical normal.

* Los parámetros T-S han sido medidos después de un periodo de fatiga y estabilización de las suspensiones, mediante transductor laser de velocidad-corriente, y son el reflejo de los parámetros a largo plazo del altavoz, una vez éste haya sido instalado y haya trabajado en un corto espacio de tiempo.